

# Overview

# CHOGORI

Solar Tracking

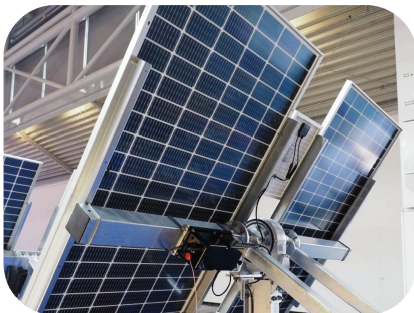

RES



LED Lighting



Electric Lawn Mower



Smart Meter



GPS Tracking



Smart Agriculture



Security



Industry Automation



Marine



AGV



Robotic



Electric Vehicle



# Overview

# CHOGORI

Product Series / Industry	Mini	Standard	Middle	Large	M15	M12	RJ45	USB	CPL	FC	FAC	KR	BangaX	Mate	CAC
Solar		★	★				★	★							
Energy Storage	★	★	★	★		★	★	★	★	★	★		★		
LED Lighting	★	★	★	★	★	★	★								★
Electric Lawn Mower		★	★	★				★				★	★		★
Smart Terminal/Meter	★	★	★	★		★	★	★							
GPS Tracking	★	★	★	★		★	★	★							
Marine	★	★	★	★		★									
Security							★								
Industry Automation	★	★	★			★	★								
Robotic		★	★	★			★	★		★		★			
AGV		★	★	★		★								★	
Smart Agriculture		★	★			★									
Electric Vehicle	★	★	★			★		★	★					★	

Application-  
Solar Tracking



**CHOGORI**

Tracker



Motor



Middle Series 3Pin for Power Transmission  
(Screw Type, 20A, UL Certified)



# Application - Commercial ESS



CPL Single Pole for Power Transmission  
(120A/200A/300A) Quick Lock

## Application - Portable ESS

**CHOGORI**

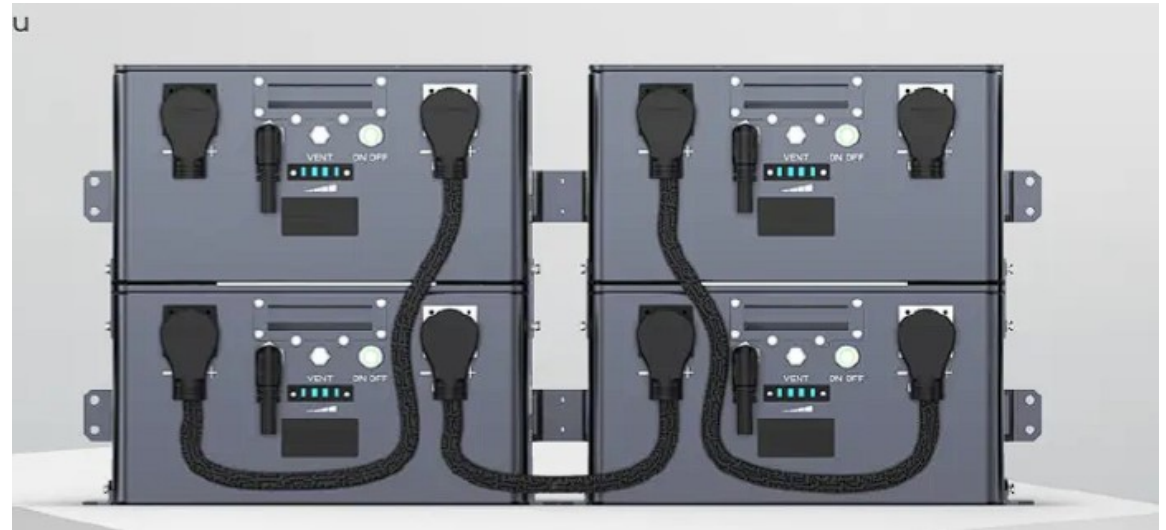

### **BangaX100**

2+1+7Pin Power and Data Transmission

100A+25A+5A

Buckle Latch Lock

IP67

Mating Cycle: 3000 Times

Application - RES



FC31  
3+14Pin  
Power and Data Transmission  
70A+3A  
Stack connector

RJ45



# Application - RES



Mini 6pin  
Data Transmission  
2A IP67



CPL Single Pole for Power Transmission  
(120A)

Application  
- LED Lighting

Architectural Lighting

**CHOGORI**



**Burj Khalifa**

Source: <https://www.saco.com/burj-khalifa-dubai>



Standard 2+4P Cable to Panel Connector

Power and Data Transmission

Push Lock

10A+2A

IP67 Rated

UL Certified



Application  
- LED Lighting

Architectural Lighting

**CHOGORI**

MSG Sphere Las Vegas



Mate 2P Cable to Panel Connector

Push Lock

35A

IP67 Rated

UL Certified

Source: <https://www.youtube.com/watch?v=GUsY8ocXVuk&t=1s>

Application  
- LED Lighting

Architectural Lighting

**CHOGORI**



Middle 5P Cable to Cable Connector

Screw Type

10A

IP67(Mated)

UL Certified



Application  
- LED Lighting

Street Light

**CHOGORI**

## M15 Connections

Standard Interface for LED  
Street Lighting



2P Cable to Cable Connector

Screw Type

10A

IP68

UL,TUV Certified

Chinese Street Light National Standard Interface

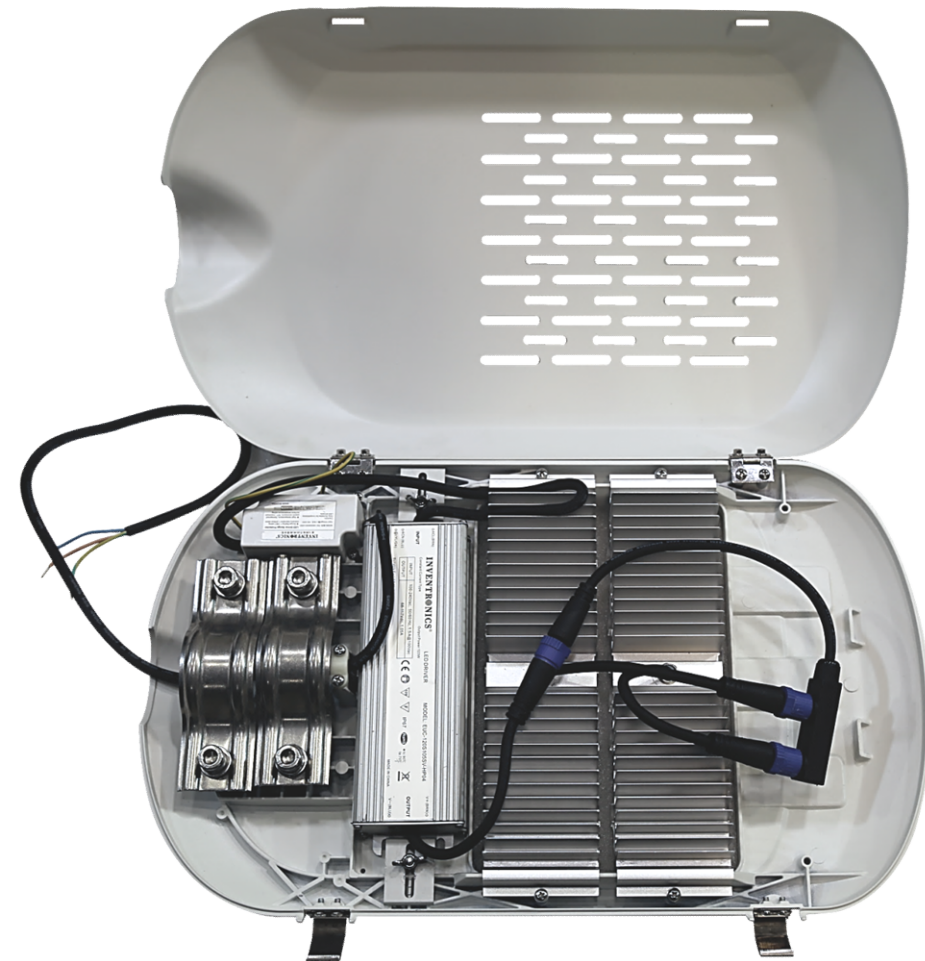

Application  
- LED Lighting

LED Display Screen

**CHOGORI**

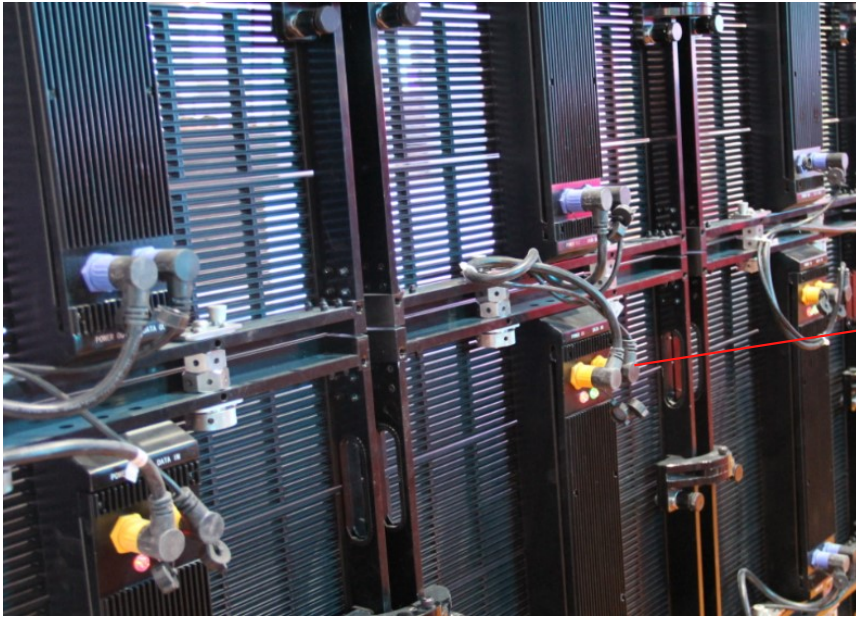

Middle 3P(20A)&8P(5A)  
Cable to Panel, Push Lock



CAC3  
3P(20A)

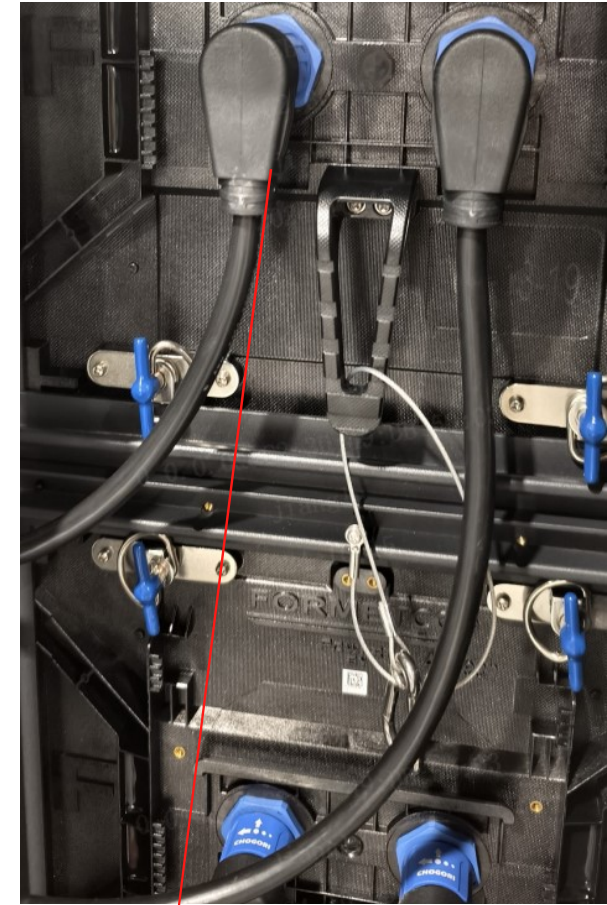
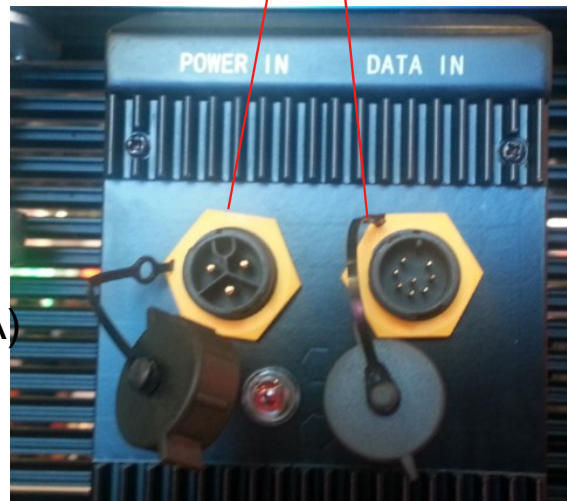

Large 2+13 Cable to Panel  
20A+5A Push Lock

Application  
-Electric Lawn Mower

**CHOGORI**

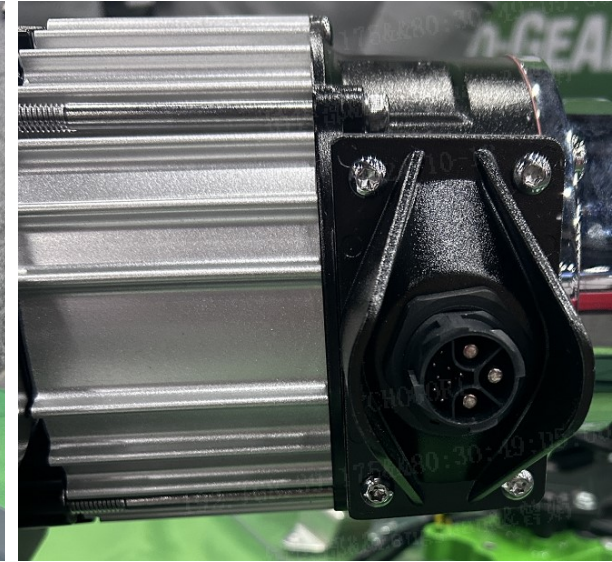

Large3P & 3+8P 50A using on the motor for discharging



HG01/02 2+6P 20A /80A  
Charging Plug and Charging Port  
on the vehicle



# Application -Electric Lawn Mower

**CHOGORI**



Power+ 骑乘式割草机



Power+ 割草机



Power+ 吹风机



**KR 2+6 Push Lock**  
40A+2A  
Power and Data  
Transmission

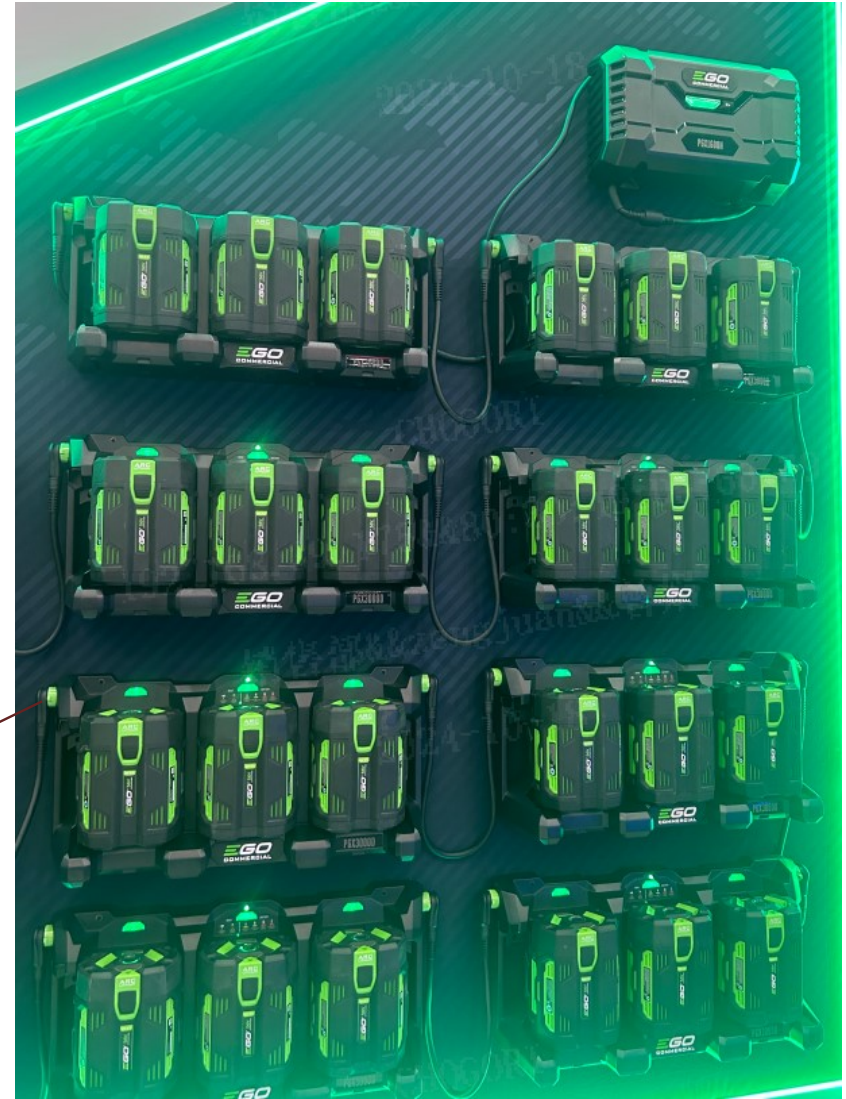

## Application - Water Meter

### Sensor /Antenna



Mini 4P Cable to Cable Connector  
Screw Type  
3A  
IP68 (6 months)  
UV Resistant

## CHOGORI

### Water/Gas/Electricity Meter



### Water/Gas/Electricity pipe

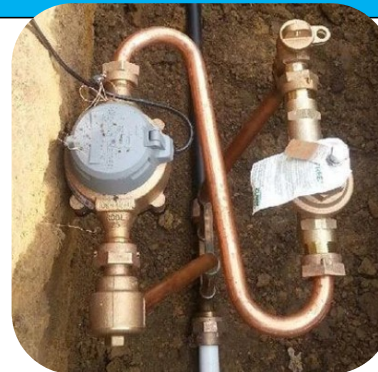

Housing, Building  
, Utility pole

Application  
-GPS Tracking

**CHOGORI**

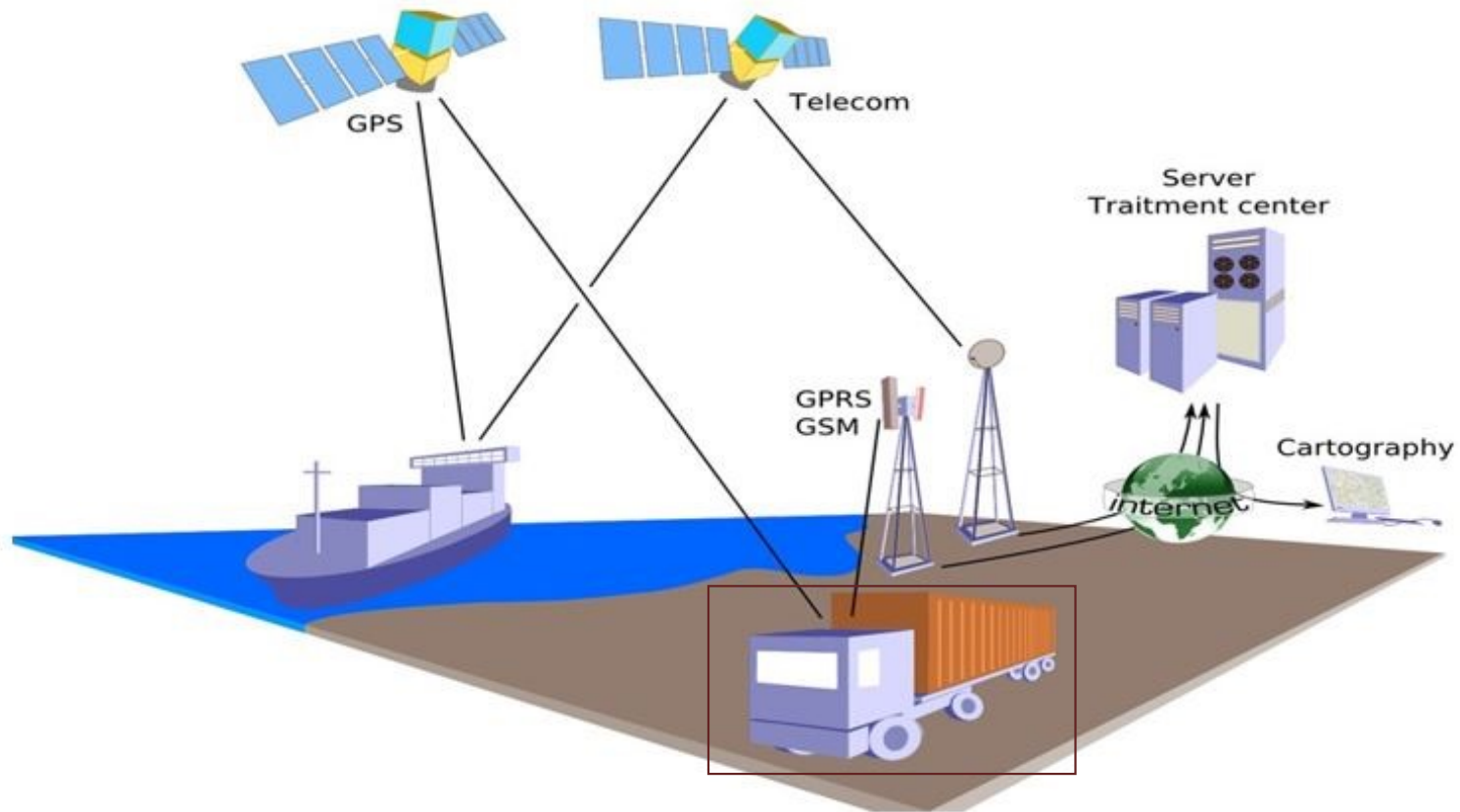

**GPS Tracking Ecosystem**  
(Source: Wikimedia Images)

# Application -GPS Tracking

## CHOGORI



Middle10P



Standard 8P

Standard 12P

Using on the tracking system of the truck for data transmission

Application-  
Smart Agriculture

**CHOGORI**

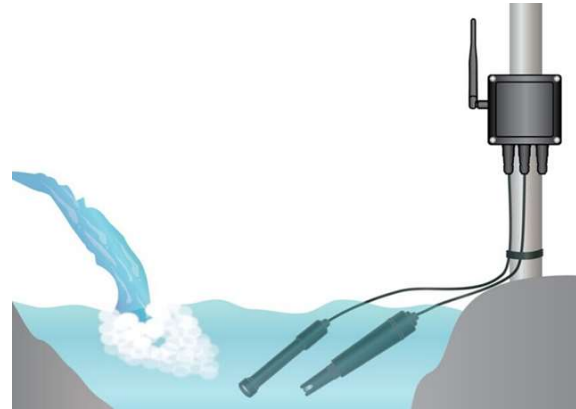

Middle series connector  
using on the controller of  
the Agricultural Aircraft

KR 2+6 connector using on  
the load of the spraying  
drone



Standard series 6pin using  
on the device to detect the  
soil and water condition

Application -  
Security



**CHOGORI**



Standard 3+4Pin Screw type  
10A+2A



M8 Series  
3/4Pin Connector

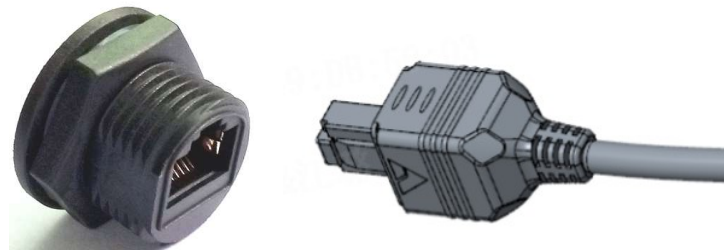

RJ45  
Waterproof Connector

Application  
-Industry Automation

**CHOGORI**



M12 Series Connector



Application-  
Marine



Antenna Splitter



**CHOGORI**

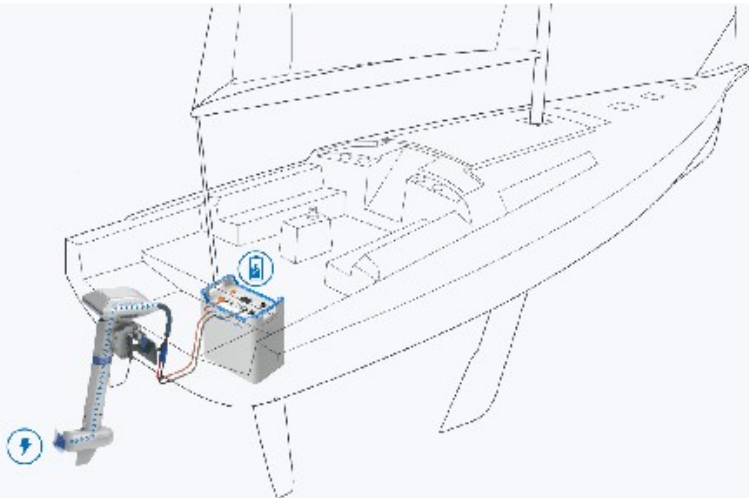

Propulsion System



AIS Vessel Tracking Solution



Application  
- AGV (Automatic Guided Vehicle)

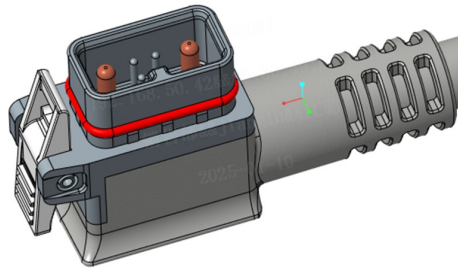
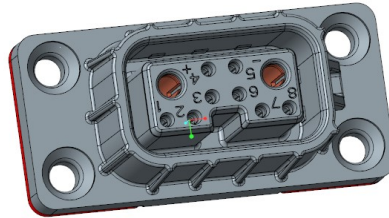

AGV 2+8 15A(Custom)



Mate 2+4,60A,Push Lock

**CHOGORI**

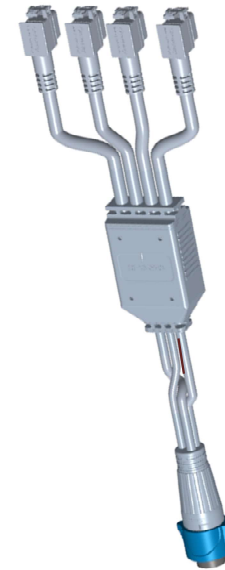
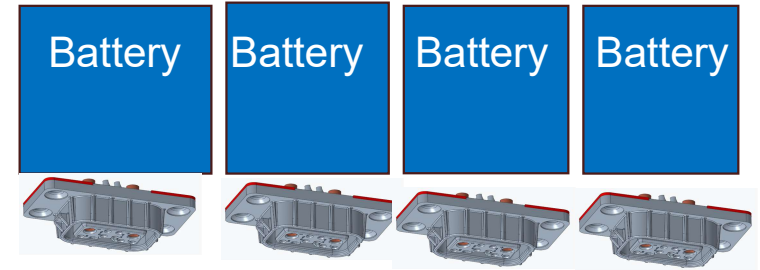

15A

Splitter

Mate 2+8  
60A



Power Control

Application  
-Robotic



**Service robot**  
For hotel and restaurant



**CHOGORI**



KR 2+6 40A(Buckle Lock) for Charging and Discharging