

**SMT Female Headers** 2,54mm pitch

2,54mm pitch **SMT** female header with precision „Jumbo Contact“ for board to board connections.

Accepts square pins 0,65 x 0,65mm max. (Pin Headers), as well as round pins  $\varnothing$  0,65 to 0,85mm max.

The female headers are available in any number of contacts, up to a maximum of 50 for the single row, and 100 for the double row.

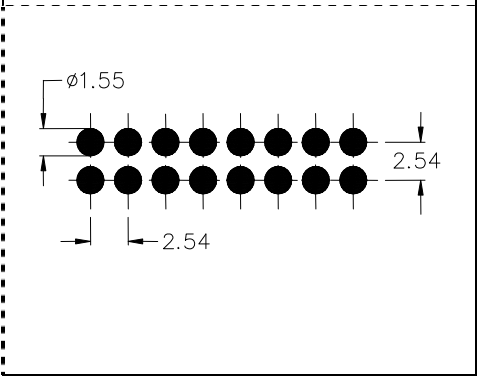
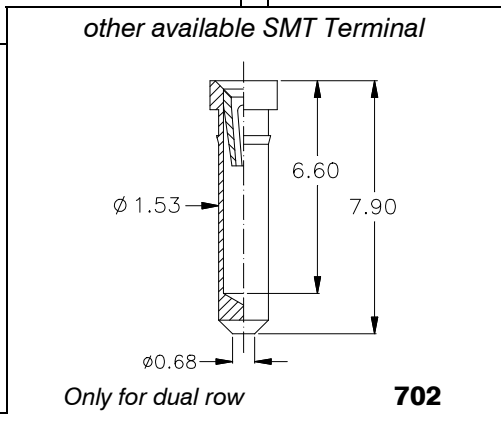
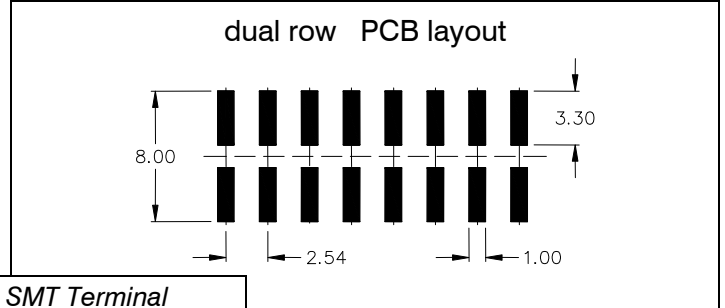
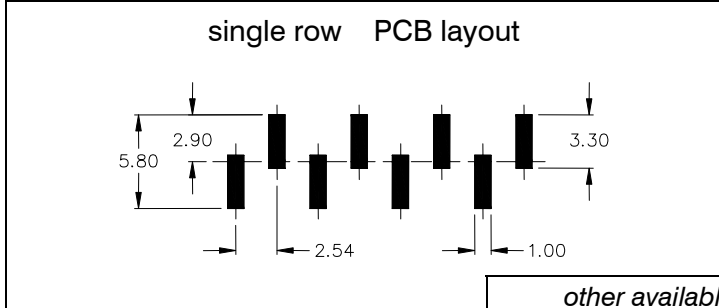
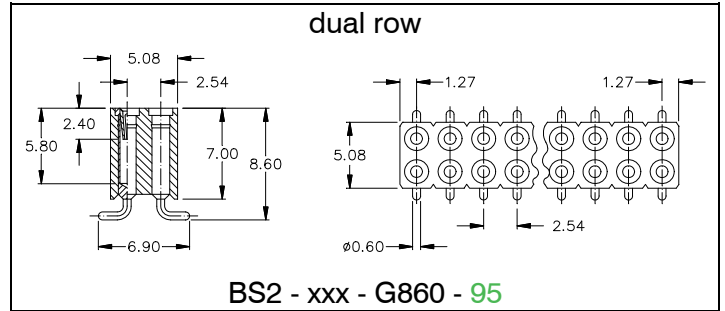
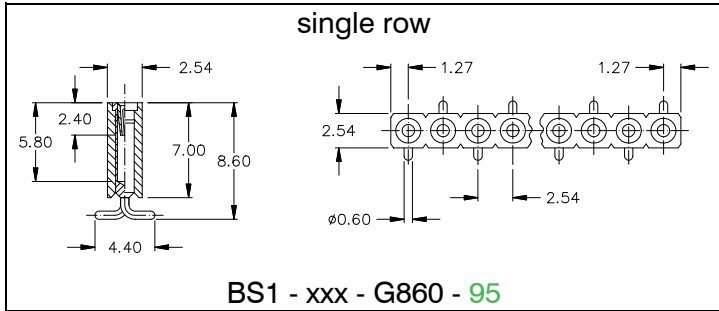
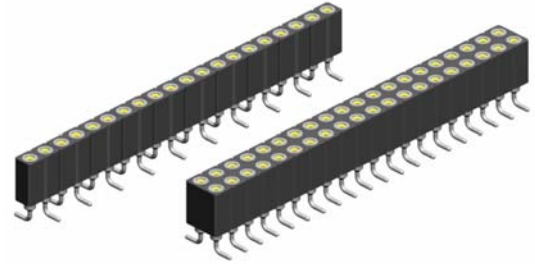

**Specifications**

**Mechanical data**

Insertion force (test probe $\varnothing$ 0,66)	2,00 N if Terminal 860
Extraction force (test probe $\varnothing$ 0,66)	1,00 N for all Terminals
Contact life	> 100 cycles
Operating temperature	-55° C to +125° C
Processing Temperature	+250°C +0/-5°C for 20~40sec.

**Material**

Insulator	(RoHS compliant) high temp plastic UL 94 V-0
Terminal	(RoHS compliant) CuZn
Contact	(RoHS compliant) BeCu

**Electrical data**

Insulation resistance	10 <sup>4</sup> M $\Omega$ min.
Breakdown voltage	500 V AC for 1 minute
Contact resistance	30 m $\Omega$ / contact max.
Current rating	3 A max., 100V

**Insertion depth**

maximum	depends on the Terminal style
minimum	4,0mm / .157"

**How to order**

**BSX - xxx - G xxx - xx**

