

Commercial Version MIL-C-5015 Compatible

A
D/MS



D/MS series connectors are intermateable and intermountable with MIL-C-5015 connectors.

The D/MS series offers:

- Hard dielectric interior (diallyl phthalate)
- Zinc plated die cast aluminum shells with Trivalent chromate finish (no cadmium is used)
- A selection of over 73 insert arrangements spanning 12 shell sizes and 5 contact sizes
- Pre-solder cup terminations
- A choice of class A (one-piece) and class B (two-piece) backshell configuration

D/MS series connector are designed for use in a wide range of general industrial applications.

FEATURE

- Improved Dielectric Withstanding Voltage (DWV):

An insulation barrier ridge between each contact position effectively increases the creepage distance across the surfaces of the insert, thus increasing DWV.

- Stable Insert Dielectric Material:

Molded Diallyl Phthalate inserts maintain their dielectric, mechanical, and dimensional properties over a wide range of temperature, humidity, and aging conditions.

- Wide Range Configurations:

A choice of over 73 insert arrangements, plus a variety of shell styles and hardware, results in a range of configurations to meet most application needs.

- Shells Keyed to Prevent Mis-Mating:

Receptacle key and plug keyway mate before contacts engage to ensure proper contact mating. Alternate rotated insert positions further ensure against mis-mating of similar connectors.

- Superior Strength of Coupling Ring:

Coupling rings are machined from bar stock to provide superior coupling thread strength as compared to die cast products.

- Quick and Easy Termination:

Contacts are pre-loaded in the connector. Pre-solder cups are permanently oriented in one direction to simplify termination.

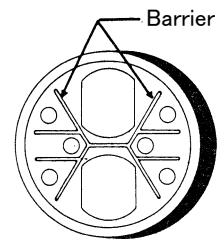

DDK



OTHER

D/MS Series

A
D/MS

APPLICATION

The D/MS series is designed and manufactured for reliable performance in a broad range of electric/electronic equipment applications. These include machine tools, communications, instrumentation and high current systems.

MATERIAL/FINISH

Contact	Copper alloy/Silver or optional Gold plating
Insulator	Diallyl phthalate resin/Blue
Shell	Aluminum alloy/Zinc plating, Trivalent Chromate finish (Black)
Coupling Ring	Aluminum alloy/Zinc plating, Trivalent Chromate finish (Black)
Retaining Ring	Phosphor bronze/Nickel plating
Cap	Aluminum alloy/Zinc plating, Trivalent Chromate finish (Black)
Chain	Stainless steel

Specification

Wire Size

Contact Size	Wire Size
#16	AWG#16—#22
#12	AWG#12—#14
#8	AWG#8—#10
#4	AWG#4—#6
#0	AWG#0—#2

Contact Current Rating

Contact Size	Test current (Amperes)
#16	13
#12	23
#8	46
#4	80
#0	150

Service Rating





Service Rating	Operating Voltage (V)	
	DC	AC
INST	250	200
A	700	500
D	1250	900
E	1750	1250
B	2450	1750
C	4200	3000

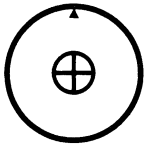

Maximum total current connector is the same as the allowable current for wire bundles as specified in MIL-W-5088.

D/MS Series

A
D/MS

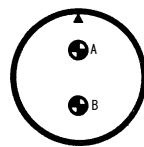
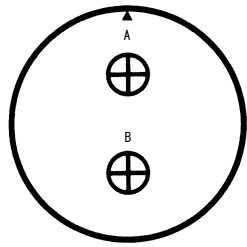
Insert Arrangements (Front View of Pin Insert)

1 Contact	2 Contacts				
 <p>20-2 1-#0 Serv. D</p>	 <p>10SL-4 2-#16 Serv. A</p>	 <p>12S-3 2-#16 Serv. A</p>	 <p>14S-9 2-#16 Serv. A</p>	 <p>20-23 2-#8 Serv. A</p>	 <p>32-5 2-#0 Serv. D</p>

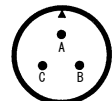
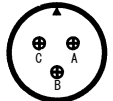
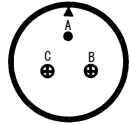
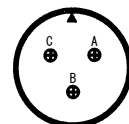
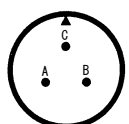
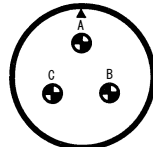
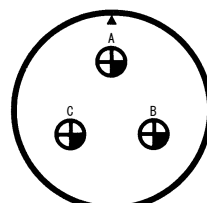
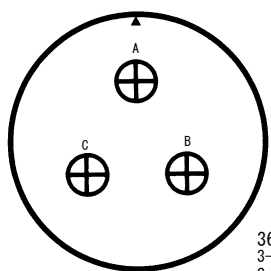
3 Contacts						
 <p>10SL-3 3-#16 Serv. A</p>	 <p>14S-1 3-#16 Serv. A</p>	 <p>14S-7 3-#16 Serv. A</p>	 <p>16S-5 3-#16 Serv. A</p>	 <p>16-10 3-#12 Serv. A</p>	 <p>18-5 2-#12, 1-#16 Serv. D</p>	 <p>18-21 3-#12 Serv. A</p>
 <p>18-22 3-#16 Serv. D</p>	 <p>22-2 3-#8 Serv. D</p>	 <p>28-6 3-#4 Serv. D</p>	 <p>36-4 3-#0 Serv. D (A) A (BC)</p>			

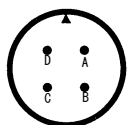
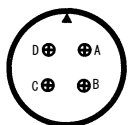
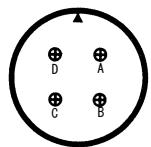
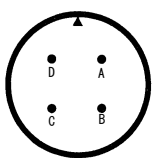
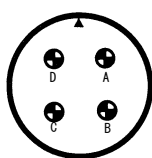
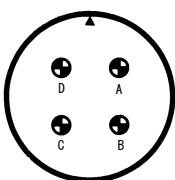
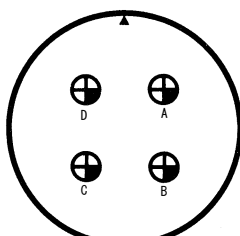
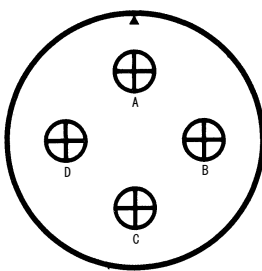
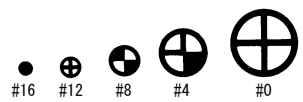
4 Contacts					
 <p>14S-2 4-#16 Serv. INST</p>	 <p>18-4 4-#16 Serv. D</p>	 <p>18-10 4-#12 Serv. A</p>	 <p>20-4 4-#12 Serv. D</p>	 <p>22-10 4-#16 Serv. E</p>	 <p>22-22 4-#8 Serv. A</p>
 <p>24-22 4-#8 Serv. D</p>	 <p>32-17 4-#4 Serv. D</p>	 <p>36-5 4-#0 Serv. A</p>	<p>Contact Sizes</p>  <p>#16 #12 #8 #4 #0</p>		

D/MS Series

A
D/MS

Insert Arrangements (Front View of Pin Insert)

5 Contacts		6 Contacts					
<p>14S-5 5-#16 Serv. INST</p>	<p>16S-8 5-#16 Serv. A</p>	<p>18-11 5-#12</p>	<p>18-20 5-#16</p>				
<p>32-1 2-#0, 3-#12 Serv. E(A) D(Others)</p>		<p>32-2 3-#4, 2-#16 Serv. E</p>					
		<p>14S-6 6-#16 Serv. INST</p>		<p>18-12 6-#16 Serv. A</p>	<p>20-17 5-#12, 1-#16 Serv. A</p>		
		<p>20-22 3-#8, 3-#16 Serv. A</p>		<p>36-3 3-#0, 3-#12 Serv. D</p>			
7 Contacts			8 Contacts		9 Contacts		
<p>16S-1 7-#16 Serv. A</p>	<p>20-15 7-#12 Serv. A</p>	<p>22-28 7-#12 Serv. A</p>	<p>18-8 1-#12, 7-#16 Serv. A</p>	<p>20-16 2-#12, 7-#16 Serv. A</p>			
<p>24-2 7-#12 Serv. D</p>	<p>24-10 7-#8 Serv. A</p>	<p>28-10 2-#4, 2-#8, 3-#12 Serv. D(G) A(Others)</p>	<p>20-7 8-#16 Serv. D(ABHG) A(CDEF)</p>	<p>20-18 3-#12, 6-#16 Serv. A</p>			
			<p>22-23 8-#12 Serv. D(H) A(Others)</p>	<p>24-11 3-#8, 6-#12 Serv. A</p>			
10 Contacts		11 Contacts		14 Contacts			
<p>18-1 10-#16 Serv. A(BCFG) INST(Others)</p>	<p>24-20 2-#12, 9-#16 Serv. D</p>		<p>20-27 14-#16 Serv. A</p>	<p>22-19 14-#16 Serv. A</p>	<p>28-20 10-#12, 4-#16 Serv. A</p>		
<p>18-19 10-#16 Serv. A</p>			<p>32-9 2-#4, 12-#16 Serv. D</p>				
							<p>Contact Sizes</p> <p>#16 #12 #8 #4 #0</p>

D/MS Series

A
D/MS

Insert Arrangements (Front View of Pin Insert)

16 Contacts	17 Contacts	19 Contacts	20 Contacts
<p>24-5 16-#16 Serv. A</p>	<p>24-7 2-#12, 14-#16 Serv. A</p>	<p>20-29 17-#16 Serv. A</p>	<p>28-16 20-#16 Serv. A</p>
22 Contacts	24 Contacts	26 Contacts	30 Contacts
<p>28-11 4-#12, 18-#16 Serv. A</p>	<p>24-28 24-#16 Serv. A</p>	<p>28-12 26-#16 Serv. A</p>	<p>32-8 6-#12, 24-#16 Serv. A</p>
31 Contacts	35 Contacts	37 Contacts	
<p>36-9 1-#4, 2-#8 14-#12, 14-#16 Serv. A</p>	<p>28-15 35-#16 Serv. A</p>	<p>32-7 7-#12, 28-#16 Serv. INST (ABh) A (others)</p> <p>28-21 37-#12 Serv. A</p>	
48 Contacts	52 Contacts	54 Contacts	73 Contacts
<p>36-10 48-#16 Serv. A</p>	<p>32-414 52-#16 Serv. A</p>	<p>32A-10 54-#16 Serv. A</p>	<p>36-73 73-#16 Serv. A</p>

Contact Sizes



D/MS Series

A
D/MS

Alternate Insert Positions

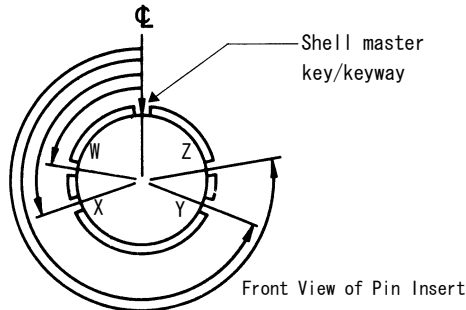

No. of Contacts	Insert No.	W	X	Y	Z
1	20-2	—	—	—	—
	10SL-4	—	—	—	—
2	12S-3	70°	145°	215°	290°
	14S-9	70°	145°	215°	290°
	20-23	35°	110°	250°	325°
	32-5	35°	110°	250°	325°
	10SL-3	—	—	—	—
3	14S-1	—	—	—	—
	14S-7	90°	180°	270°	—
	16S-5	70°	145°	215°	290°
	16-10	90°	180°	270°	—
	18-5	80°	110°	250°	280°
	18-21	—	—	—	—
	18-22	70°	145°	215°	290°
	22-2	70°	145°	215°	290°
	28-6	70°	145°	215°	290°
	36-4	70°	145°	215°	290°
4	14S-2	—	120°	240°	—
	18-4	35°	110°	250°	325°
	18-10	—	120°	240°	—
	20-4	45°	110°	250°	—
	22-10	35°	110°	250°	325°
	22-22	—	110°	250°	—
	24-22	45°	110°	250°	—
	32-17	45°	110°	250°	—
	36-5	—	120°	240°	—
	14S-5	—	110°	—	—
5	16S-8	—	170°	265°	—
	18-11	—	170°	265°	—
	18-20	90°	180°	270°	—
	32-1	80°	110°	250°	280°
	32-2	70°	145°	215°	290°
6	14S-6	—	—	—	—
	18-12	80°	—	—	280°
	20-17	90°	180°	270°	—
	20-22	80°	—	250°	280°
36-3	70°	145°	215°	290°	

No. of Contacts	Insert No.	W	X	Y	Z
7	16S-1	80°	—	—	280°
	20-15	80°	—	—	280°
	22-28	80°	—	—	280°
	24-2	80°	—	—	280°
	24-10	80°	—	—	280°
8	28-10	80°	110°	250°	280°
	18-8	70°	—	—	290°
	20-7	80°	110°	250°	280°
9	22-23	35°	—	—	—
	20-16	80°	110°	250°	280°
	20-18	35°	110°	250°	325°
10	24-11	35°	110°	250°	325°
	18-1	70°	145°	215°	290°
11	18-19	—	120°	240°	—
	24-20	80°	110°	250°	280°
14	20-27	35°	110°	250°	325°
	22-19	80°	110°	250°	280°
	28-20	80°	110°	250°	280°
16	32-9	80°	110°	250°	280°
	24-5	80°	110°	250°	280°
17	24-7	80°	110°	250°	280°
	20-29	80°	—	—	280°
19	22-14	80°	110°	250°	280°
20	28-16	80°	110°	250°	280°
22	28-11	80°	110°	250°	280°
24	24-28	80°	110°	250°	280°
26	28-12	90°	180°	270°	—
30	32-8	80°	125°	235°	280°
31	36-9	80°	125°	235°	280°
35	28-15	80°	110°	250°	280°
	32-7	80°	125°	235°	280°
37	28-21	80°	110°	250°	280°
48	36-10	80°	125°	235°	280°
52	32-414	80°	110°	250°	280°
54	32A-10	—	—	—	—
73	36-73	80°	110°	250°	280°

D/MS Series

Insert Specifications

A
D/MS

Insert Number	No. of Contacts	Service Rating	Contact Size				
			#0	#4	#8	#12	#16
10SL-3	3	A					3
10SL-4	2	A					2
12S-3	2	A					2
14S-1	3	A					3
14S-2	4	INST					4
14S-5	5	INST					5
14S-6	6	INST					6
14S-7	3	A					3
14S-9	2	A					2
16S-1	7	A					7
16S-5	3	A					3
16S-8	5	A					5
16-10	3	A				3	
18-1	10	A					4
		INST					6
18-4	4	D					4
18-5	3	D				2	1
18-8	8	A				1	7
18-10	4	A				4	
18-11	5	A				5	
18-12	6	A					6
18-19	10	A					10
18-20	5	A					5
18-21	3	A				3	
18-22	3	D					3
20-2	1	D	1				
20-4	4	D				4	
20-7	8	D					4
		A					4
20-15	7	A				7	
20-16	9	A				2	7
20-17	6	A				5	1
20-18	9	A				3	6
20-22	6	A				3	3
20-23	2	A				2	
20-27	14	A					14
20-29	17	A					17
22-2	3	D				3	
22-10	4	E					4
22-14	19	A					19

Insert Number	No. of Contacts	Service Rating	Contact Size				
			#0	#4	#8	#12	#16
22-19	14	A					14
22-22	4	A				4	
22-23	8	D					1
		A					7
22-28	7	A					7
24-2	7	D					7
24-5	16	A					16
24-7	16	A					2
24-10	7	A				7	
24-11	9	A				3	6
24-20	11	D					2
24-22	4	D				4	
24-28	24	INST					24
28-6	3	D				3	
28-10	7	D					1
		A				2	2
28-11	22	A				4	18
28-12	26	A					26
28-15	35	A					35
28-16	20	A					20
28-20	14	A					10
28-21	37	A					37
32-1	5	E					1
		D	2				2
32-2	5	E				3	2
32-5	2	D	2				
32-7	35	A					7
		INST					4
32-8	30	A					6
32-9	14	D				2	12
32A-10	54	A					54
32-17	4	D				4	
32-414	52	A					52
36-3	6	D	3				3
36-4	3	D	1				
		A	2				
36-5	4	A	4				
36-9	31	A				1	2
36-10	48	A					14
36-73	73	A					48

Note : Insert number 10SL-3 and 10SL-4 are available with the following part numbers only:

D/MS3102A10SL-3P, DMS3102A10SL-4P

D/MS3106A10SL-3S, DMS3106A10SL-4S

D/MS Series

Unit : mm

A
D/MS

D/MS3102A28-21SY(62)

SELL STYLE

3100A : Wall Mounting Receptacle, Solid Shell
 3101A : Cable Connecting Receptacle, Solid Shell
 3102A : Box Mounting Receptacle
 3106A : Straight Plug, Solid Shell
 3106B : Straight Plug, Split Shell
 3108B : Angle Plug, Split Shell

INSERT ARRANGEMENT

See page 3 to 5

DEVIATION

Omit : Silver plated contacts
 (62) : Gold plated contacts

ALTERNATE INSERT POSITION

Omit : Standard position
 W.X.Y.Z : Alternate position

CONTACT STYLE

P : Pin
 S : Socket

Wall Mounting Receptacle, Solid Shell

D/MS3100A

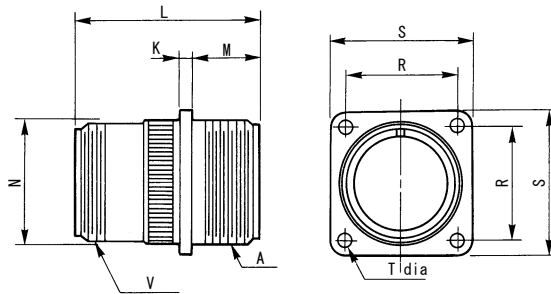

Shell Size	Coupling Threads A	K	L	M	N	R	S	T	Rear Threads V
12S	3/4-20UNEF	2.1	37.9	14.28	19.89	20.62	27.8	3.05	5/8-24UNEF
14S	7/8-20UNEF	2.1	37.5	14.28	22.29	23.01	30.2	3.05	3/4-20UNEF
16S	1-20UNEF	2.1	37.5	14.28	25.45	24.61	32.5	3.05	7/8-20UNEF
16	1-20UNEF	3.2	47.9	19.05	25.45	24.61	32.5	3.05	7/8-20UNEF
18	1 1/8-18UNEF	3.2	51.1	19.05	28.64	26.97	34.9	3.05	1-20UNEF
20	1 1/4-18UNEF	3.2	54.0	19.05	31.81	29.36	38.1	3.05	1 3/16-18UNEF
22	1 3/8-18UNEF	3.2	54.0	19.05	34.99	31.75	41.3	3.05	1 3/16-18UNEF
24	1 1/2-18UNEF	3.2	57.2	20.63	38.15	34.92	44.4	3.74	1 7/16-18UNEF
28	1 3/4-18UNS	3.2	57.2	20.63	44.51	39.67	50.8	3.74	1 7/16-18UNEF
32	2-18UNS	3.7	60.4	22.23	51.24	44.45	57.2	4.40	1 3/4-18UNS
36	2 1/4-16UN	3.7	60.4	22.23	57.21	49.23	63.5	4.40	2-18UNS

D/MS Series

Unit : mm

■ Cable Connecting Receptacle, Solid Shell

A
D/MS

D/MS3101A

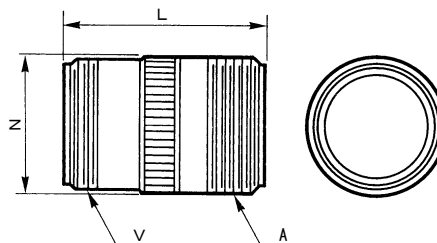

Shell Size	Coupling Threads A	L	N	Rear Threads V
12S	$\frac{3}{4}$ -20UNEF	37.9	19.90	$\frac{5}{8}$ -24UNEF
14S	$\frac{7}{8}$ -20UNEF	37.5	22.29	$\frac{3}{4}$ -20UNEF
16S	1-20UNEF	37.5	25.47	$\frac{7}{8}$ -20UNEF
16	1-20UNEF	47.9	25.47	$\frac{7}{8}$ -20UNEF
18	1 $\frac{1}{8}$ -18UNEF	51.1	28.64	1-20UNEF
20	1 $\frac{1}{4}$ -18UNEF	54.0	31.81	1 $\frac{3}{16}$ -18UNEF
22	1 $\frac{3}{8}$ -18UNEF	54.0	34.99	1 $\frac{3}{16}$ -18UNEF
24	1 $\frac{1}{2}$ -18UNEF	57.2	38.17	1 $\frac{7}{16}$ -18UNEF
28	1 $\frac{3}{4}$ -18UNS	57.2	44.52	1 $\frac{7}{16}$ -18UNEF
32	2-18UNS	60.4	51.25	1 $\frac{3}{4}$ -18UNS
36	2 $\frac{1}{4}$ -16UN	60.4	57.22	2-18UNS

D/MS Series

Unit : mm

A
D/MS

■ Box Mounting Receptacle

D/MS3102A

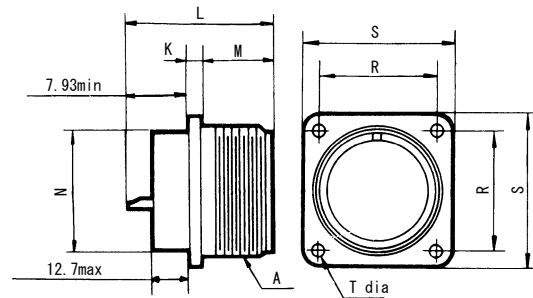
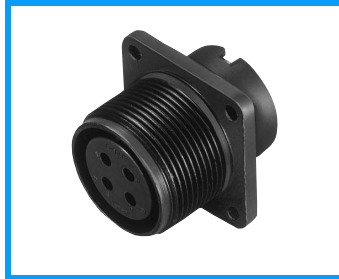

Shell Size	Coupling Threads A	K	L	M	N	R	S	T
10SL	$\frac{5}{8}$ -24UNEF	2.1	30.25	14.28	15.9	18.26	25.4	3.05
12S	$\frac{3}{4}$ -20UNEF	2.1	30.25	14.28	17.5	20.62	27.8	3.05
14S	$\frac{7}{8}$ -20UNEF	2.1	30.25	14.28	19.1	23.01	30.2	3.05
16S	1-20UNEF	2.1	30.25	14.28	22.2	24.61	32.5	3.05
16	1-20UNEF	3.2	44.45	19.05	22.4	24.61	32.5	3.05
18	1 $\frac{1}{8}$ -18UNEF	3.2	49.22	19.05	25.4	26.97	34.9	3.05
20	1 $\frac{1}{4}$ -18UNEF	3.2	49.22	19.05	28.6	29.36	38.1	3.05
22	1 $\frac{3}{8}$ -18UNEF	3.2	49.22	19.05	31.8	31.75	41.3	3.05
24	1 $\frac{1}{2}$ -18UNEF	3.2	49.22	20.63	34.9	34.92	44.4	3.74
28	1 $\frac{3}{4}$ -18UNS	3.2	49.22	20.63	41.3	39.67	50.8	3.74
32	2-18UNS	3.7	49.22	22.23	48.4	44.45	57.2	4.40
36	2 $\frac{1}{4}$ -16UN	3.7	49.22	22.23	54.0	49.23	63.5	4.40

D/MS Series

Unit : mm

■ Straight Plug, Solid Shell

A
D/MS

D/MS3106A

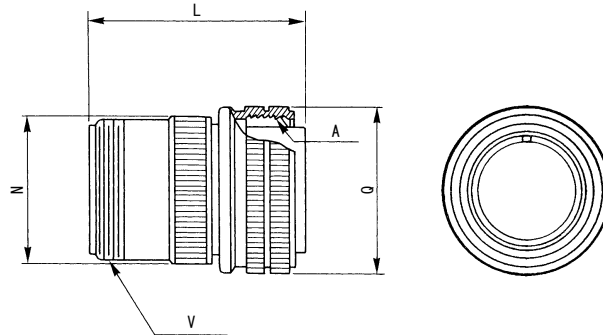

Shell Size	Coupling Threads A	L	Q	N	Rear Threads V
10SL	5/8-24UNEF	34.9	22.22	19.12	5/8-24UNEF
12S	3/4-20UNEF	36.5	25.40	19.89	5/8-24UNEF
14S	7/8-20UNEF	36.5	28.57	22.29	3/4-20UNEF
16S	1-20UNEF	36.9	31.75	25.45	7/8-20UNEF
16	1-20UNEF	48.0	31.75	25.45	7/8-20UNEF
18	1 1/8-18UNEF	50.8	34.13	28.64	1-20UNEF
20	1 1/4-18UNEF	54.0	37.28	31.81	1 3/16-18UNEF
22	1 3/8-18UNEF	54.0	40.48	34.99	1 3/16-18UNEF
24	1 1/2-18UNEF	57.2	43.63	38.15	1 7/16-18UNEF
28	1 3/4-18UNS	57.2	50.00	44.51	1 7/16-18UNEF
32	2-18UNS	60.3	56.33	51.24	1 3/4-18UNS
36	2 1/4-16UN	60.3	62.68	57.21	2-18UNS

D/MS Series

Unit : mm

A
D/MS

■ Straight Plug, Split Shell

D/MS3106B

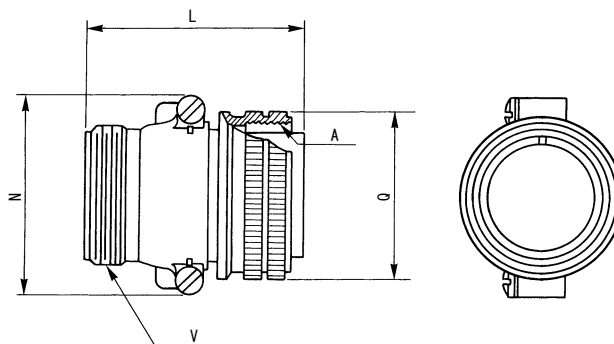

Shell Size	Coupling Threads A	L	Q	N	Rear Threads V
12S	$\frac{3}{4}$ -20UNEF	42.88	25.40	26.97	$\frac{5}{8}$ -24UNEF
14S	$\frac{7}{8}$ -20UNEF	42.88	28.57	30.00	$\frac{3}{4}$ -20UNEF
16S	1-20UNEF	42.88	31.75	32.00	$\frac{7}{8}$ -20UNEF
16	1-20UNEF	52.37	31.75	32.00	$\frac{7}{8}$ -20UNEF
18	1 $\frac{1}{8}$ -18UNEF	52.37	34.13	41.68	1-20UNEF
20	1 $\frac{1}{4}$ -18UNEF	55.57	37.28	46.02	1 $\frac{3}{16}$ -18UNEF
22	1 $\frac{3}{8}$ -18UNEF	55.57	40.48	49.22	1 $\frac{3}{16}$ -18UNEF
24	1 $\frac{1}{2}$ -18UNEF	58.72	43.63	52.37	1 $\frac{7}{16}$ -18UNEF
28	1 $\frac{3}{4}$ -18UNS	58.72	50.00	58.72	1 $\frac{7}{16}$ -18UNEF
32	2-18UNS	61.92	56.33	65.88	1 $\frac{3}{4}$ -18UNS
36	2 $\frac{1}{4}$ -16UN	61.92	62.68	72.23	2-18UNS

D/MS Series

Unit : mm

■ Angle Plug, Split Shell

A
D/MS

D/MS3108B

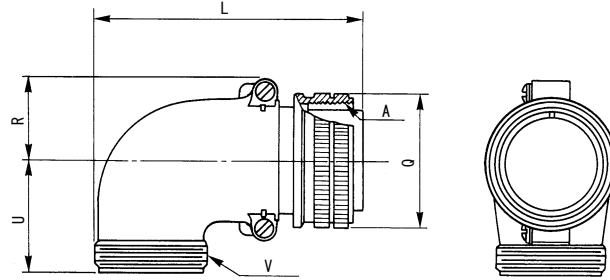

Shell Size	Coupling Threads A	L	Q	R	U	Rear Threads V
12S	3/4-20UNEF	50.80	25.4	10.5	25.4	5/8-24UNEF
14S	7/8-20UNEF	53.97	28.57	14.9	27.0	3/4-20UNEF
16S	1-20UNEF	60.32	31.75	18.5	28.6	7/8-20UNEF
16	1-20UNEF	65.07	31.75	18.5	28.6	7/8-20UNEF
18	1 1/8-18UNEF	68.27	34.13	20.5	30.2	1-20UNEF
20	1 1/4-18UNEF	76.98	37.28	22.5	33.3	1 3/16-18UNEF
22	1 3/8-18UNEF	76.98	40.48	24.1	33.3	1 3/16-18UNEF
24	1 1/2-18UNEF	86.51	43.63	25.6	36.5	1 7/16-18UNEF
28	1 3/4-18UNS	86.51	50.00	28.8	36.5	1 7/16-18UNEF
32	2-18UNS	95.25	56.33	32.8	44.4	1 3/4-18UNS
36	2 1/4-16UN	100.00	62.68	36.0	49.2	2-18UNS

D/MS Series

Unit : mm

A
D/MS

Assembly

